

KNB CORPORATION

2014

**Plastic Impeller  
Borehole Pump -  
60Hz**



# WP

are manufactured using high quality materials and are designed to deliver years of dependable service. Pumps are on the floating impeller design which reduces starting torque requirements and reduces the effects of sand in the water.

## Product Features

- Floating impeller design for sand resistance and reduces sand blocking
- Built-in check valve to prevent back flow
- SUS 304 polished stainless steel shell
- Shafts are made from hex 304 stainless steel bar material
- Built-in SUS 304 stainless steel strainer

## Product Range

1. 4" Plastic impeller submersible borehole pump  
WP-05/10/13/15/18/25/35/40  
WP- 55/60/80
2. 6" Plastic imepller submersible borehole pump  
WP-106/160/240

- 50 Hz version:  
Capable of handling flows up to 54 m<sup>3</sup>/h - Head up to 325 m
- 60 Hz version:  
Capable of handling flows up to 54 m<sup>3</sup>/h - Head up to 403 m

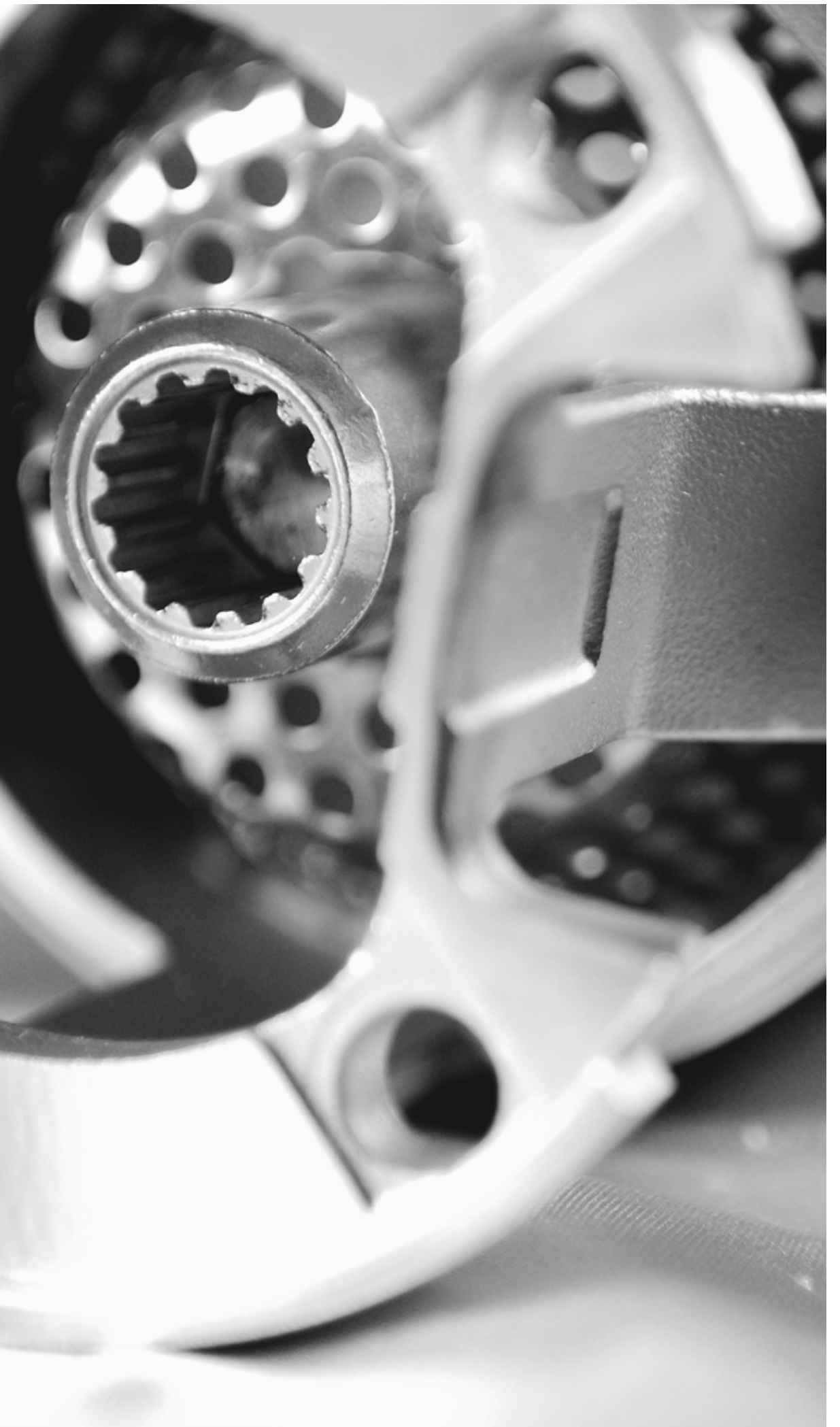
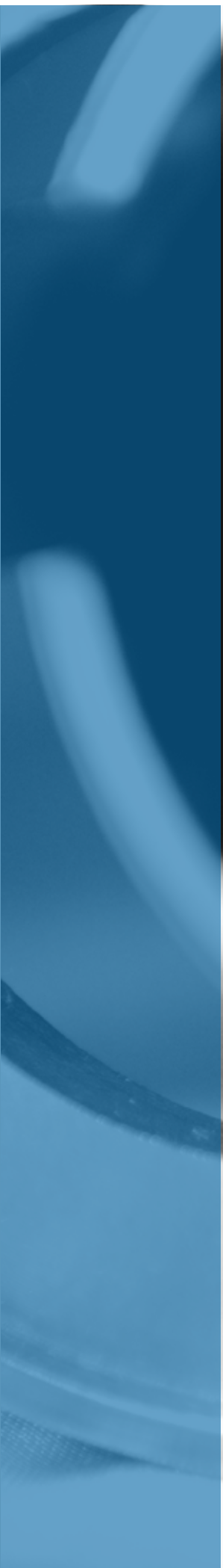

## FEATURES/APPLICATIONS



### Technical Data

- Max. sand content: 50g/m<sup>3</sup>
- pH values: 6 to 8
- Liquid Temp. up to 35°C
- Material:
  1. Impellers - POM (WP05~35) / PC/GF POLYCARBONATE+GLASS FIBER (WP40~)
  2. Diffusers - PC/GF POLYCARBONATE+GLASS FIBER

### Applications

- Residential potable water supply from deep wells
- Municipal and industrial water supply
- Irrigation and other agricultural applications
- Fire fighting systems
- Pressure boosting in high-rise buildings and other applications



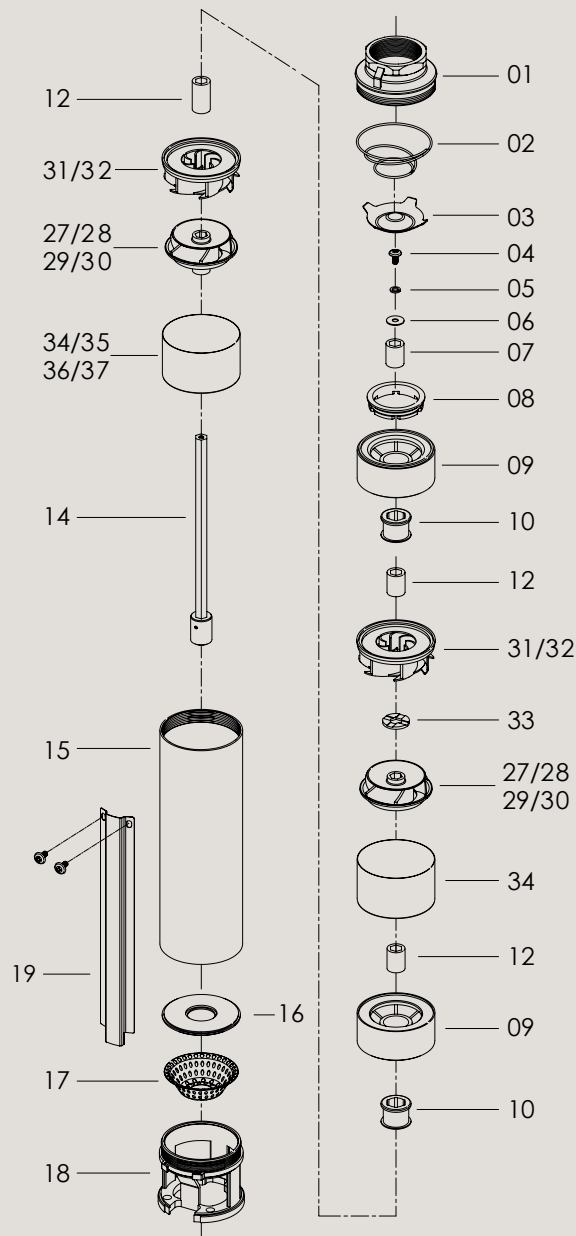
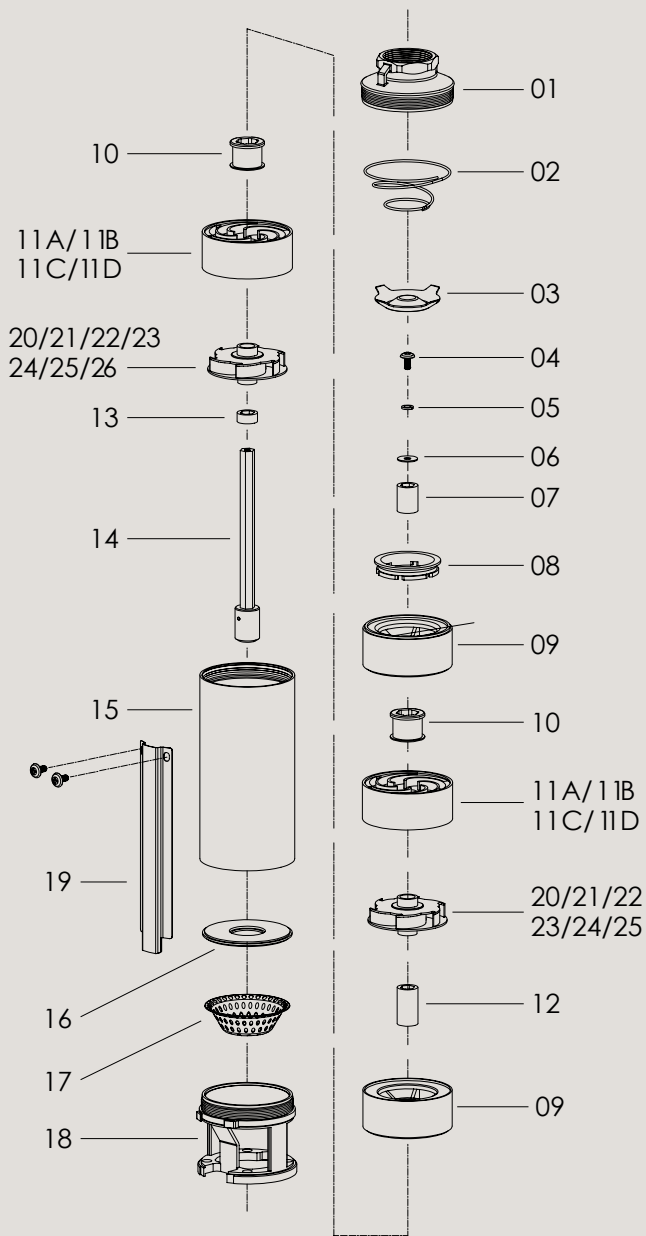

WP - 05/10/13/15/18/25/35 series

01	Dischagre	10	Rubber	17	Strainer
02	Spring	11 A	WP-05/10/13 Diffuser	18	Suction nterconnector
03	Check Valve	11 B	WP-15/18 Diffuser	19	Cable Guard
04	Screw	11 C	WP-25 Diffuser	20	WP-05 Impeller
05	Washer	11 D	WP-35 Diffuser	21	WP-10 Impeller
06	Washer	12	Shaft Sleeve	22	WP-13 Impeller
07	Shaft Sleeve (Stainel Steel)	13	Shaft Sleeve	23	WP-15 Impeller
		14	Shaft & Coupling	24	WP-18 Impeller
08	Rubber	15	Casing	25	WP-25 Impeller
09	Upper Bearing Seat	16	Stage Inlet Cover	26	WP-35 Impeller

WP - 40/55/60/80series

01	Dischagre	10	Rubber	29	WP-60 Impeller
02	Spring	12	Shaft Sleeve	30	WP-80 Impeller
03	Check Valve	14	Shaft & Coupling	31	WP-40/55/60 Diffuser
04	Screw	15	Casing	32	WP-80 Diffuser
05	Washer	16	Stage Inlet Cover	33	Spacer
06	Washer	17	Strainer	34	WP-40 Cover of Impeller (PC +GF)
		18	Suction Interconnector	35	WP-55 Cover of Impeller (PC +GF)
07	Shaft Sleeve (Stainel Steel)	19	Cable Guard	36	WP-60 Cover of Impeller (Stainless Steel)
		27	WP-40 Impeller	37	WP-80 Cover of Impeller (Stainless Steel)
08	Rubber	28	WP-55 Impeller		
09	Upper Bearing Seat				

# WP-05 series / 4 Inch / 60Hz

## Specifications & Performance Curve

6

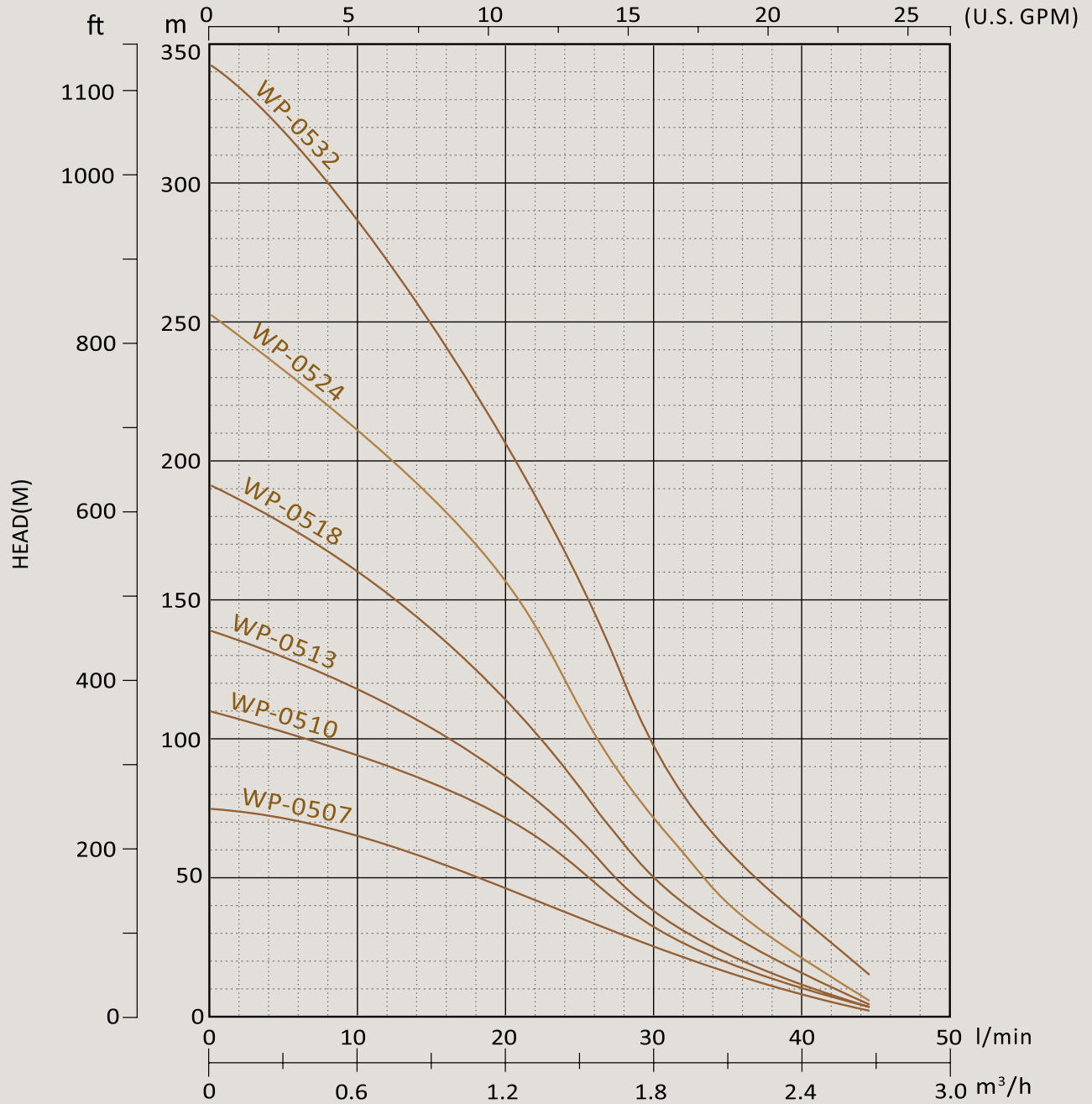

MODEL	CAPACITY		POWER		Stages	CAPACITY										Disch
	GPM	m³/hr	HP	kW		m³/hr	0	0.3	0.6	0.9	1.2	1.5	1.8	2.1	2.4	
WP-0507			0.5	0.37	7	HEAD (m)	75	70	64	56	47	36	23	13	8	
WP-0510			0.75	0.55	10		109	103	94	83	68	53	32	17	12	
WP-0513	5	1	1	0.75	13		139	130	117	102	84	62	34	18	12	
WP-0518			1.5	1.1	18		192	178	159	140	111	82	48	30	15	
WP-0524			2	1.5	24		253	230	208	186	147	106	62	35	16	
WP-0532			3	2.2	32		345	322	285	245	204	154	100	60	35	

# WP-10 series / 4 Inch / 60Hz

7

## Specifications & Performance Curve

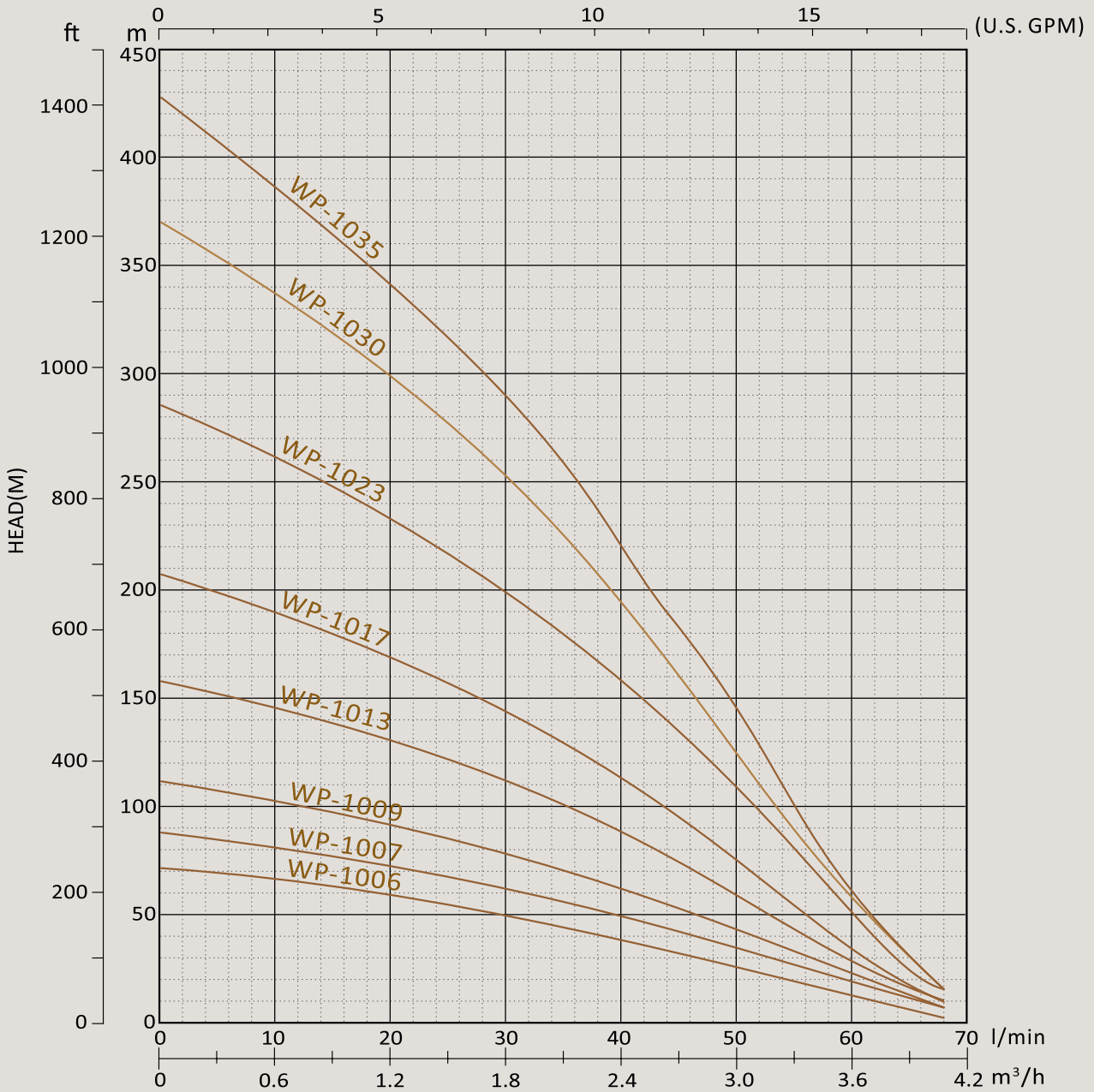

MODEL	CAPACITY		POWER		Stages	CAPACITY													Disch	
	GPM	m³/hr	HP	kW		HEAD (m)	m³/hr	0	0.3	0.6	0.9	1.2	1.5	1.8	2.1	2.4	2.7	3.0		3.6
							GPM	0	1	3	4	5	7	8	9	11	12	13		16
							LPM	0	5	10	15	20	25	30	35	40	45	50		60
WP-1006			0.50	0.37	6	71	68	65	61	58	53	48	43	37	32	25	11			
WP-1007			0.75	0.55	7	87	83	80	76	72	64	61	55	48	42	33	17			
WP-1009			1	0.75	9	111	107	102	97	92	86	78	70	61	52	42	20			
WP-1013	10	2	1.5	1.1	13	157	152	144	138	128	119	110	99	84	74	58	28	1-1/4" / 1-1/2" / 2"		
WP-1017			2	1.5	17	206	195	188	178	167	155	142	128	112	95	73	33			
WP-1023			3	2.2	23	283	272	260	248	230	213	195	177	155	135	110	49			
WP-1030			4	3	30	371	355	336	318	299	277	251	223	192	163	126	51			
WP-1035			5	3.7	35	428	403	382	361	340	318	282	250	215	181	139	51			

# WP-13 series / 4 Inch / 60Hz

## Specifications & Performance Curve

8

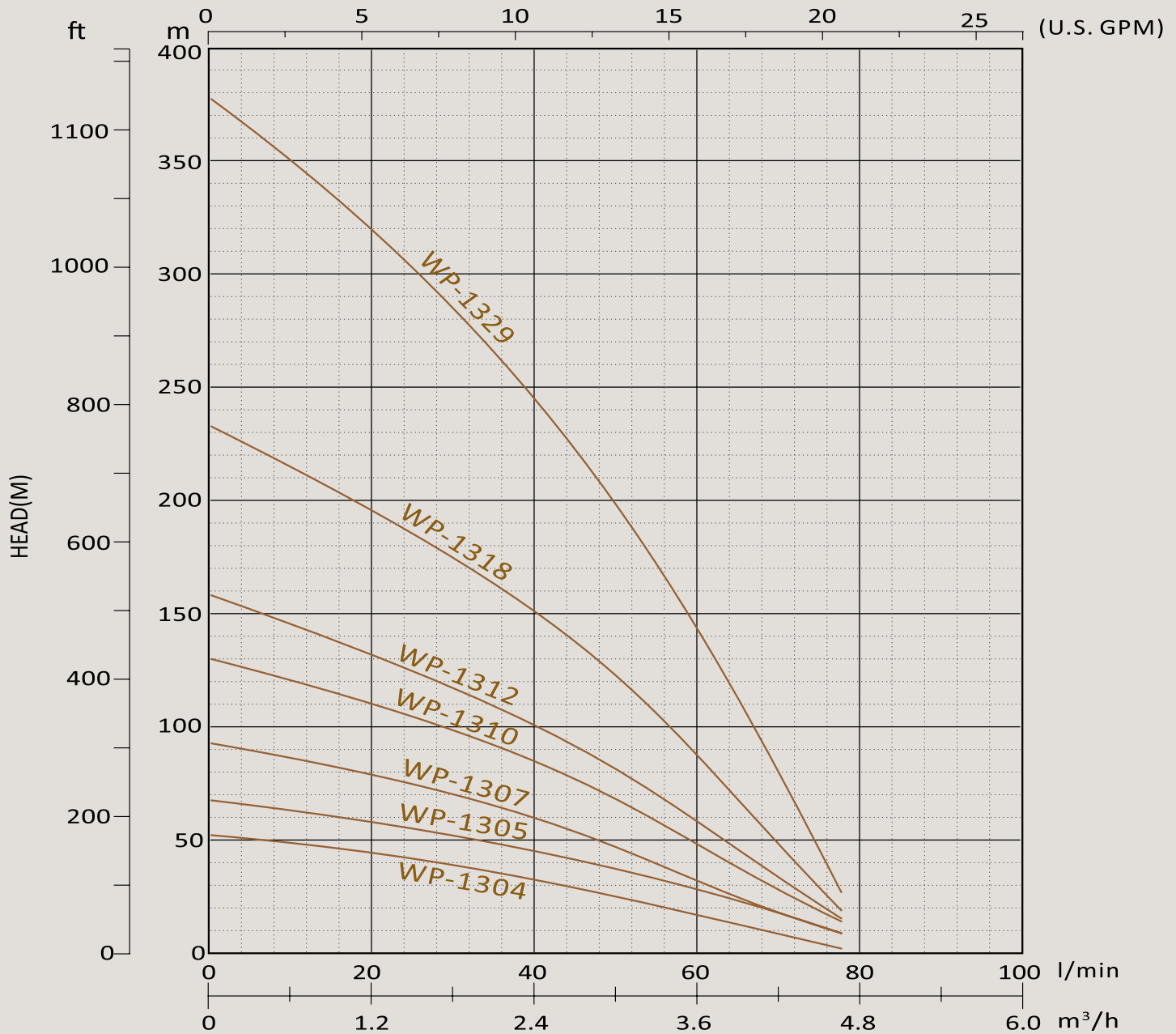

MODEL	CAPACITY		POWER		Stages	CAPACITY										Disch
	GPM	m³/hr	HP	kW		m³/hr	0	0.9	1.2	1.8	2.1	2.4	3.0	3.6	4.2	
						GPM	0	4	5	8	9	11	13	16	18	
						LPM	0	15	20	30	35	40	50	60	70	
WP-1304			0.5	0.37	4		52	46	43	38	36	32	25	17	10	
WP-1305			0.75	0.55	5		67	61	58	52	49	45	37	28	18	
WP-1307			1	0.75	7		94	83	79	70	64	59	47	32	18	
WP-1310	13	3	1.5	1.1	10	HEAD (m)	130	115	110	98	93	84	67	48	29	
WP-1312			2	1.5	12		157	139	134	117	109	100	80	58	33	
WP-1318			3	2.2	18		233	206	196	174	163	150	122	88	50	
WP-1329			5	3.7	29		378	335	318	282	265	242	200	142	80	



# WP-15 series / 4 Inch / 60Hz

9

## Specifications & Performance Curve

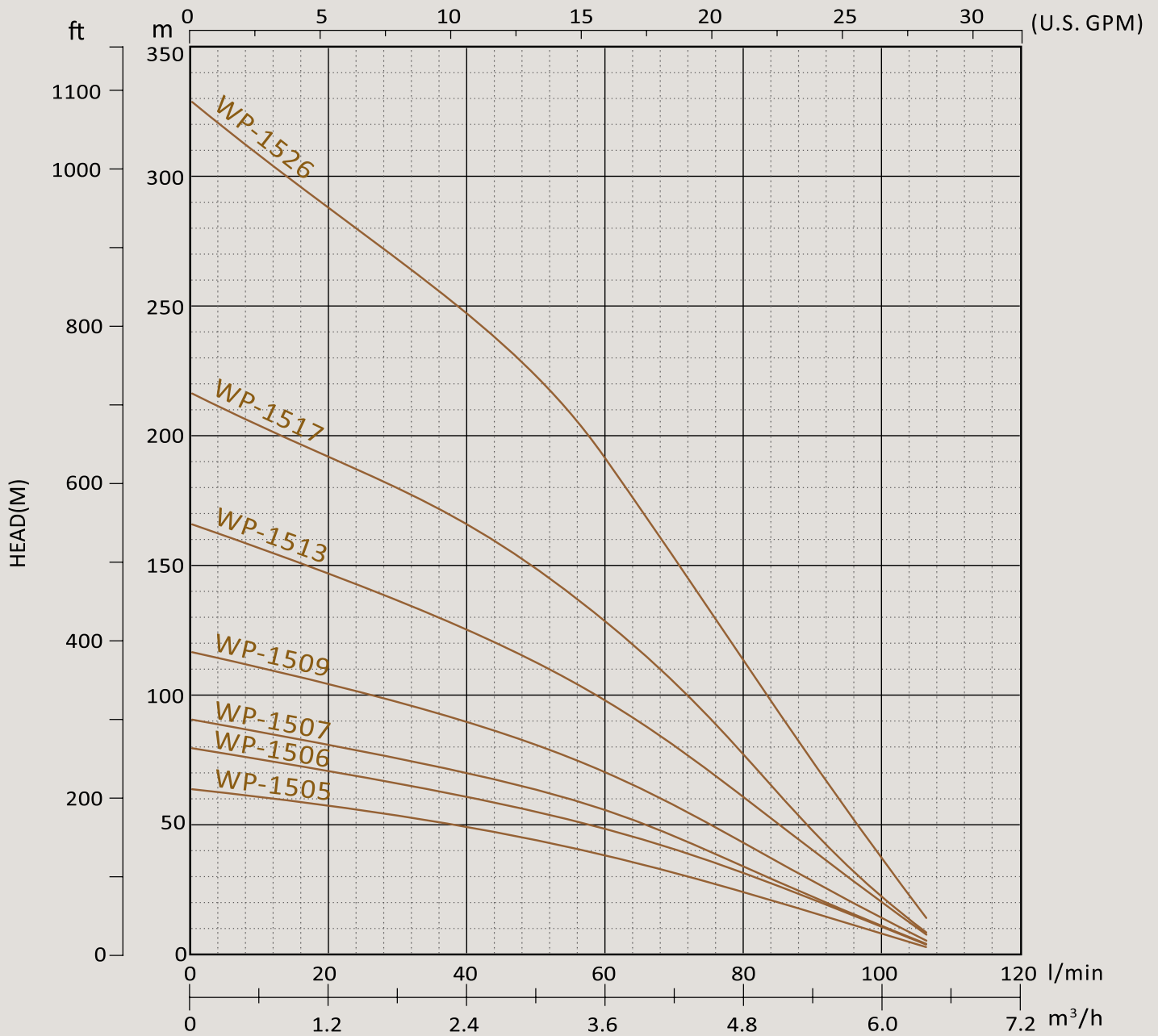

MODEL	CAPACITY		POWER		Stages	CAPACITY									Disch	
	GPM	m³/hr	HP	kW		m³/hr	0	1.2	1.8	2.4	3.0	3.6	4.2	4.8		5.4
							GPM	0	5	8	11	13	16	18		21
						LPM	0	20	30	40	50	60	70	80	90	
WP-1505			0.5	0.37	5	HEAD (m)	63	55	52	48	43	36	30	22	15	
WP-1506			0.75	0.55	6		79	69	65	61	55	47	40	31	20	
WP-1507			1	0.75	7		91	80	75	71	63	55	44	33	22	
WP-1509	15	3.4	1.5	1.1	9		116	104	95	88	81	70	57	42	27	
WP-1513			2	1.5	13		166	146	137	125	114	97	80	60	39	
WP-1517			3	2.2	17		217	190	178	163	149	125	102	74	47	
WP-1526			5	3.7	26		329	287	265	243	221	190	155	115	72	

# WP-18 series / 4 Inch / 60Hz

## Specifications & Performance Curve

10

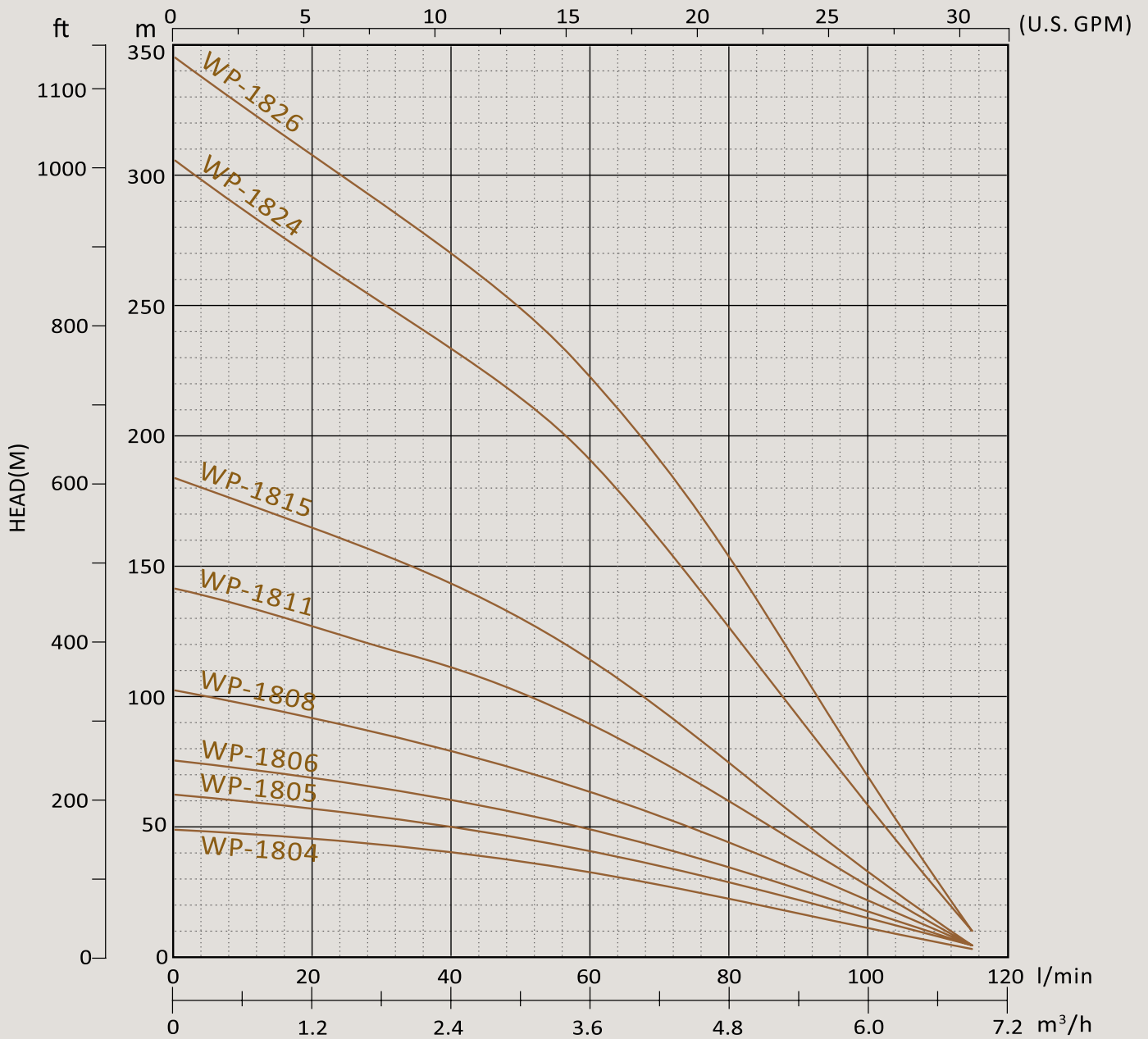

MODEL	CAPACITY		POWER		Stages	CAPACITY													Disch
	GPM	m³/hr	HP	kW		m³/hr	0	1.2	1.5	1.8	2.1	2.4	3.0	3.6	4.2	4.8	5.4	6.0	
						GPM	0	5	7	8	9	11	13	16	18	21	24	26	
						LPM	0	20	25	30	35	40	50	60	70	80	90	100	
WP-1804			0.5	0.37	4	HEAD	49	45	44	43	42	40	37	32	28	22	17	11	1-1/4" / 1-1/2" / 2"
WP-1805			0.75	0.55	5	63	57	55	54	52	50	46	40	35	28	23	16		
WP-1806			1	0.75	6	76	68	66	65	63	61	55	48	41	33	26	17		
WP-1809	18	4	1.5	1.1	9	113	100	96	94	92	87	80	68	56	46	34	22		
WP-1812			2	1.5	12	151	135	130	127	125	119	110	96	82	65	47	30		
WP-1816			3	2.2	16	201	179	174	170	166	158	144	125	106	84	66	37		
WP-1826			5	3.7	26	330	296	288	280	270	258	236	209	175	140	103	60		
WP-1830			5.5	4	30	393	351	343	332	320	306	280	249	210	168	125	70		

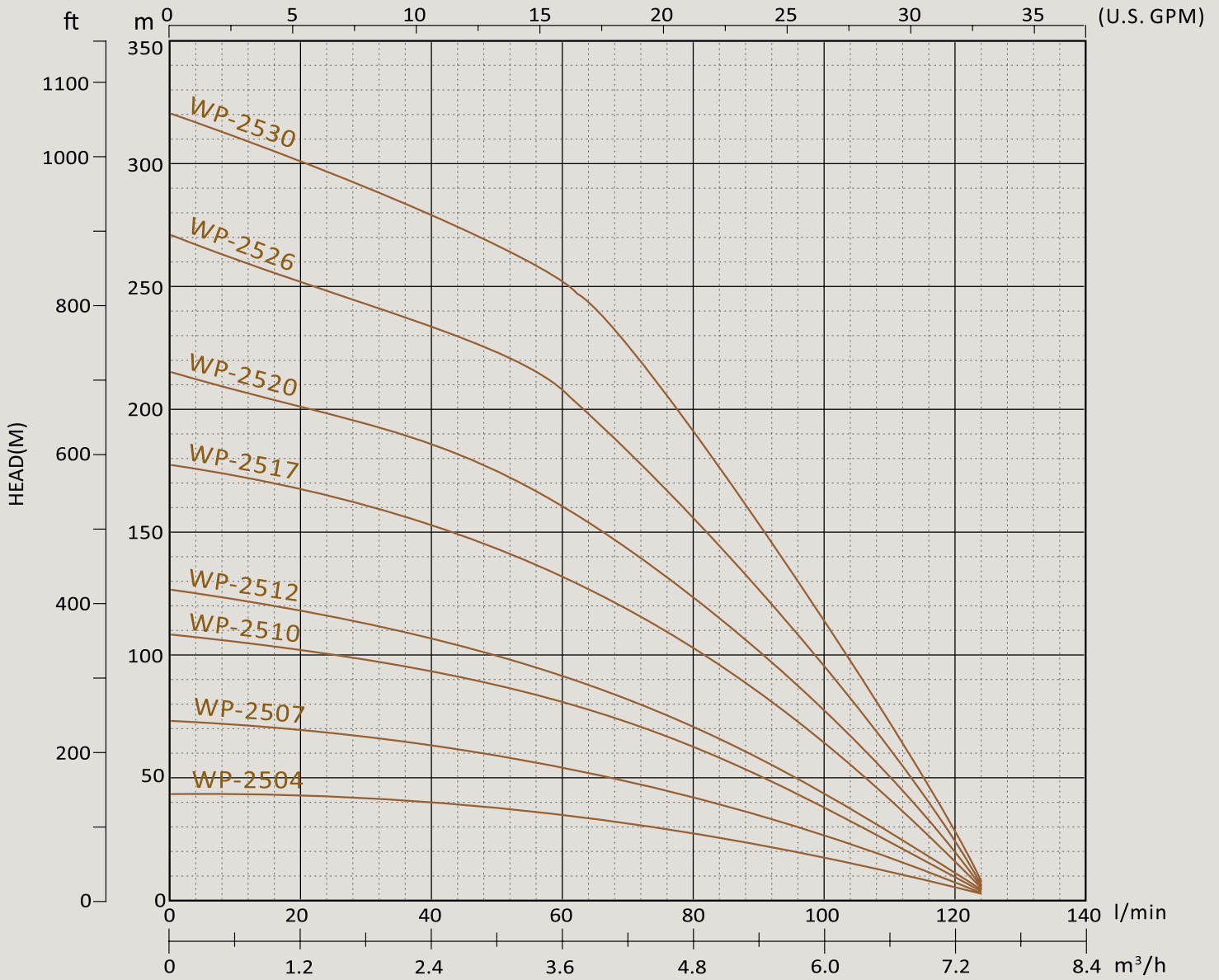

MODEL	CAPACITY		POWER		Stages	CAPACITY								Disch	
			HP	kW		m³/hr	0	2.4	3.0	3.6	4.2	4.8	5.4		6.0
						GPM	0	11	13	16	18	21	24		26
	GPM	m³/hr				LPM	0	40	50	60	70	80	90		100
WP-2504			0.5	0.37	4	43	38	35	33	28	23	20	15		
WP-2507			1	0.75	7	73	62	58	53	47	38	30	23		
WP-2510			1.5	1.1	10	108	93	85	80	70	60	50	35		
WP-2512	25	6	2	1.5	12	127	110	103	97	80	68	55	40	1-1/4" /	
WP-2517			3	2.2	17	178	152	148	135	120	90	70	50	1-1/2" /	
WP-2520			4	3	20	215	185	178	161	142	122	100	76	2"	
WP-2526			5	3.7	26	271	232	220	208	180	155	120	90		
WP-2530			5.5	4	30	320	278	262	251	220	190	155	118		

# WP-35 series / 4 Inch /60Hz

## Specifications & Performance Curve

12

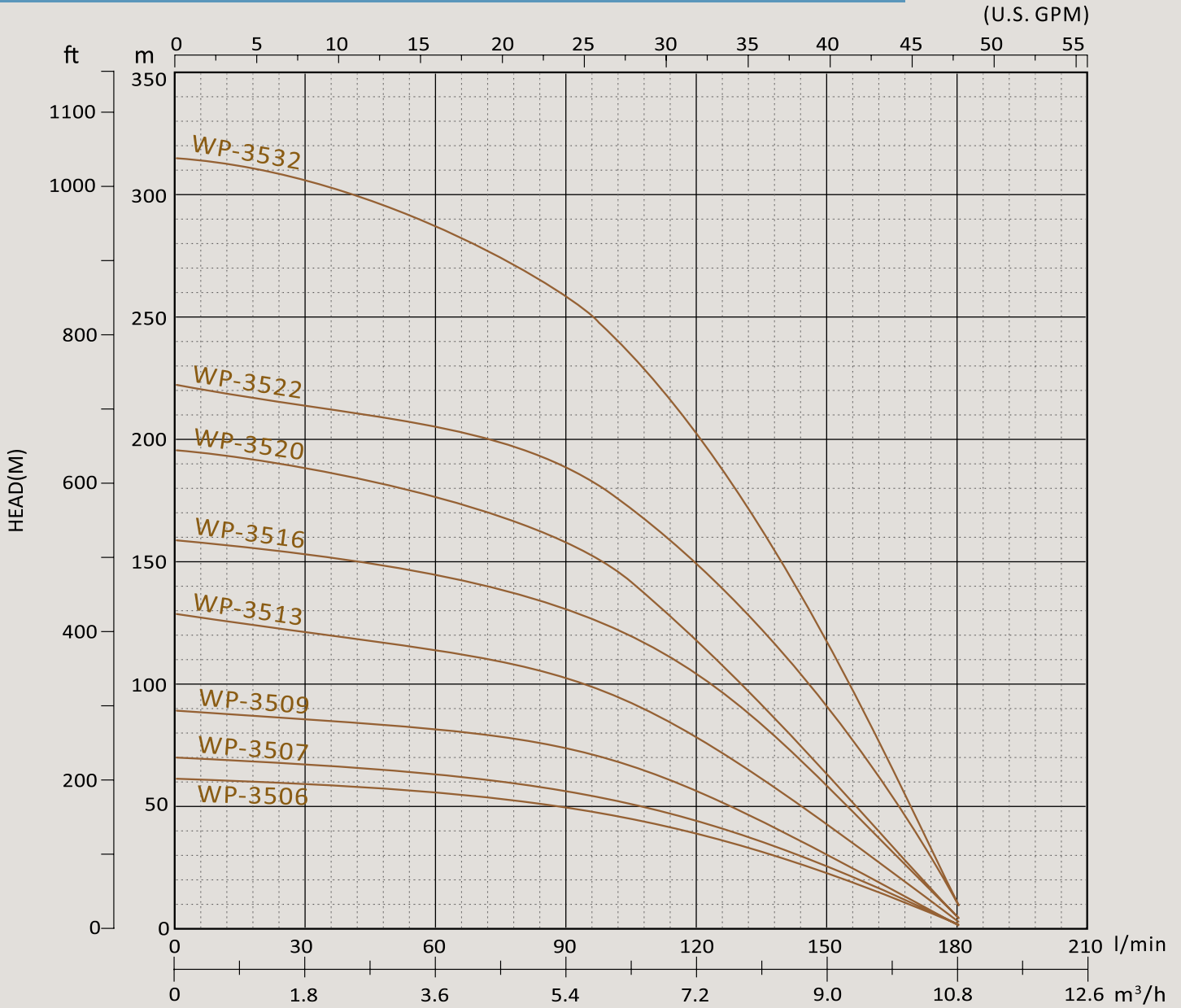

MODEL	CAPACITY		POWER		Stages	CAPACITY										Disch
	GPM	m³/hr	HP	kW		m³/hr	0	3.6	4.2	4.8	5.4	6.0	7.2	8.4	9.6	
							GPM	0	16	18	21	24	26	32	37	
WP-3506			1	0.75	6	60	54	53	52	51	46	38	28	16		
WP-3507			1.5	1.1	7	69	61	60	58	57	52	43	31	17		
WP-3509			2	1.5	9	90	81	80	78	74	69	56	40	22		
WP-3513	35	8	3	2.2	13	129	114	112	108	104	97	80	56	31		
WP-3516			4	3	16	159	142	141	136	132	123	102	74	41		
WP-3520			5	3.7	20	197	175	172	170	160	150	121	86	59		
WP-3522			5.5	4	22	221	202	198	192	189	172	147	107	62		
WP-3532			7.5	5.5	32	315	281	271	262	253	240	195	140	72		

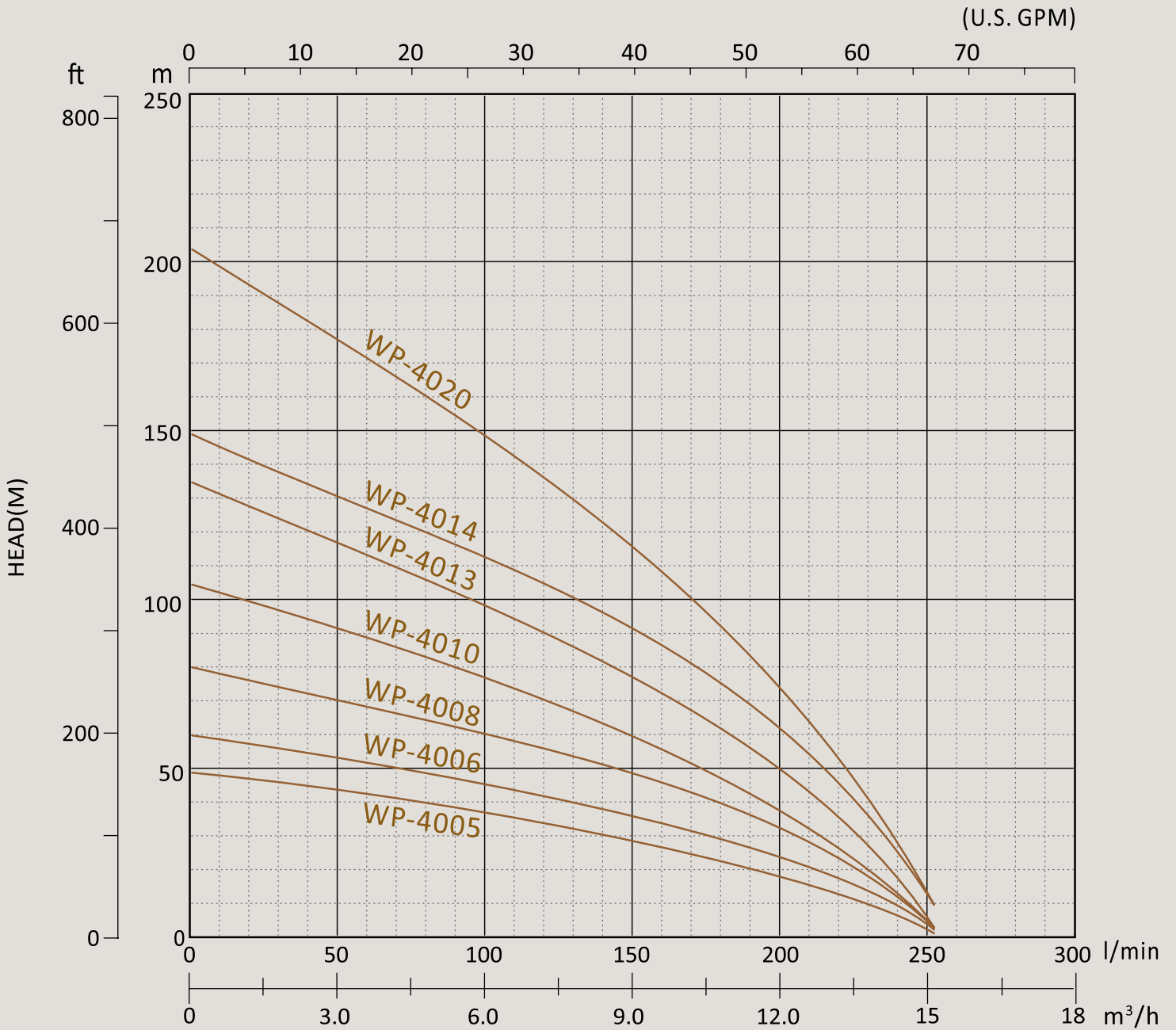

MODEL	CAPACITY		POWER		Stages	CAPACITY													Disch
	GPM	m <sup>3</sup> /hr	HP	kW		HEAD (m)													
						m <sup>3</sup> /hr	0	3.0	3.6	4.2	4.8	5.4	6.0	7.2	8.4	9.6	10.8	12.0	
WP-4005			1.5	1.1	5	49	43	42	41	39	38	36	33	30	27	23	19	1-1/4" / 1-1/2" / 2"	
WP-4006			2	1.5	6	59	52	51	50	48	46	45	41	37	33	29	24		
WP-4008			3	2.2	8	80	70	69	67	65	62	60	55	50	45	39	32		
WP-4010	40	9	4	3	10	104	91	87	85	82	79	76	69	63	55	47	39		
WP-4013			5	3.7	13	135	117	114	110	107	103	98	90	81	73	63	52		
WP-4014			5.5	4	14	149	131	127	124	120	115	111	103	94	85	76	64		
WP-4020			7.5	5.5	20	204	178	172	166	161	155	150	135	121	108	94	75		



# WP-55 series / 4 Inch / 60Hz

## Specifications & Performance Curve

14

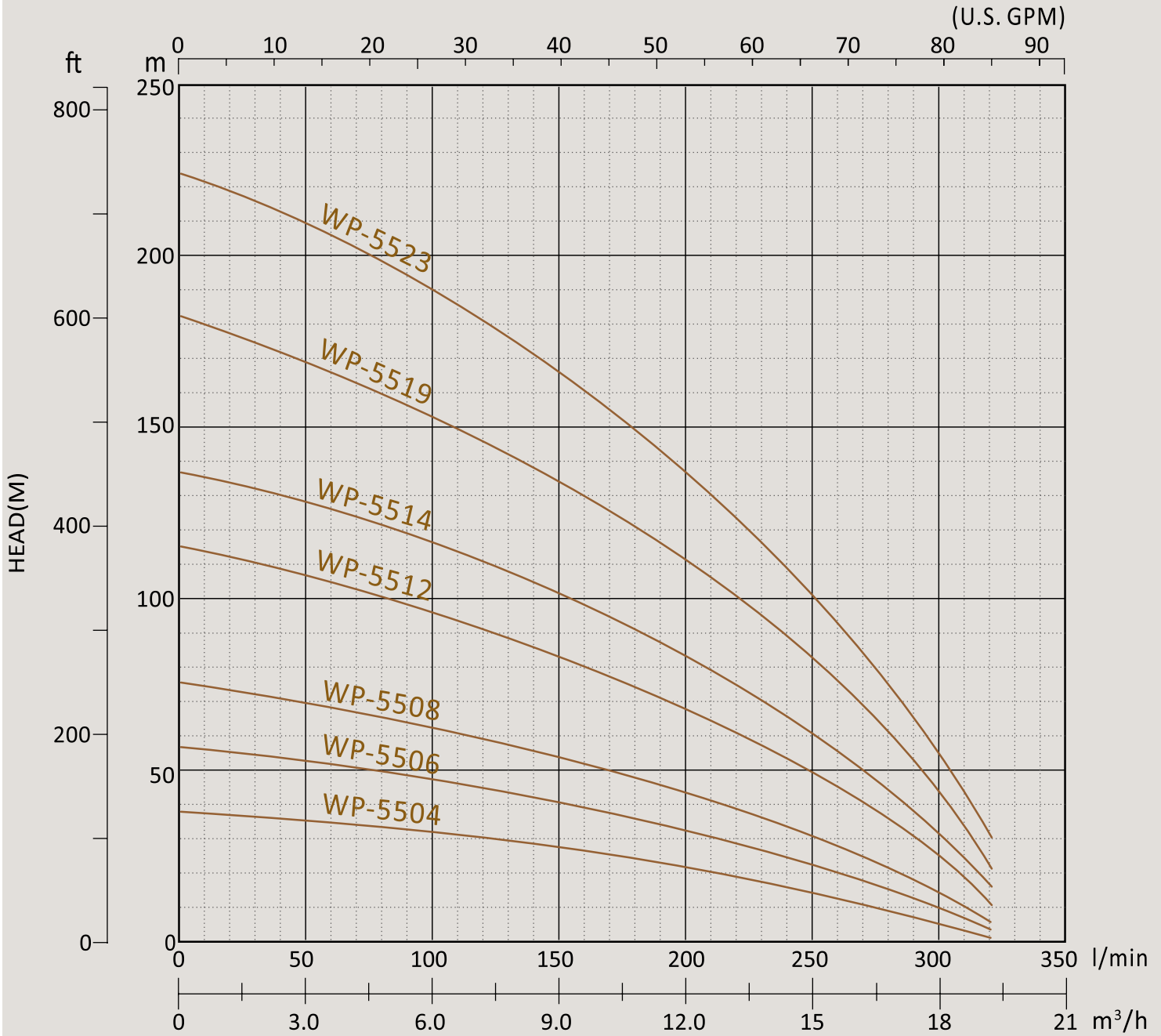

MODEL	CAPACITY		POWER		Stages	CAPACITY																Disch
	GPM	m³/hr	HP	kW		HEAD (m)																
						m³/hr	0	4.2	4.8	5.4	6.0	7.2	8.4	9.6	10.8	12.0	13.0	14.4	16.0			
WP-5504			1.5	1.1	4	38	34	33	33	32	30	28	26	23	21	19	17	13				
WP-5506			2	1.5	6	57	52	51	50	48	46	42	38	35	32	29	25	21				
WP-5508			3	2.2	8	76	67	66	65	63	60	56	52	47	43	40	35	28				
WP-5512	55	12	5	3.7	12	114	105	101	98	96	91	84	77	71	66	60	53	45	1-1/4" / 1-1/2" / 2"			
WP-5514			5.5	4	14	136	125	123	120	117	112	104	95	88	81	74	66	56				
WP-5519			7.5	5.5	19	182	164	161	158	154	145	135	125	116	107	99	90	76				
WP-5523			10	7.5	23	225	203	200	197	192	182	170	156	146	134	124	111	96				

# WP-60 series / 4 Inch / 60Hz

15

## Specifications & Performance Curve

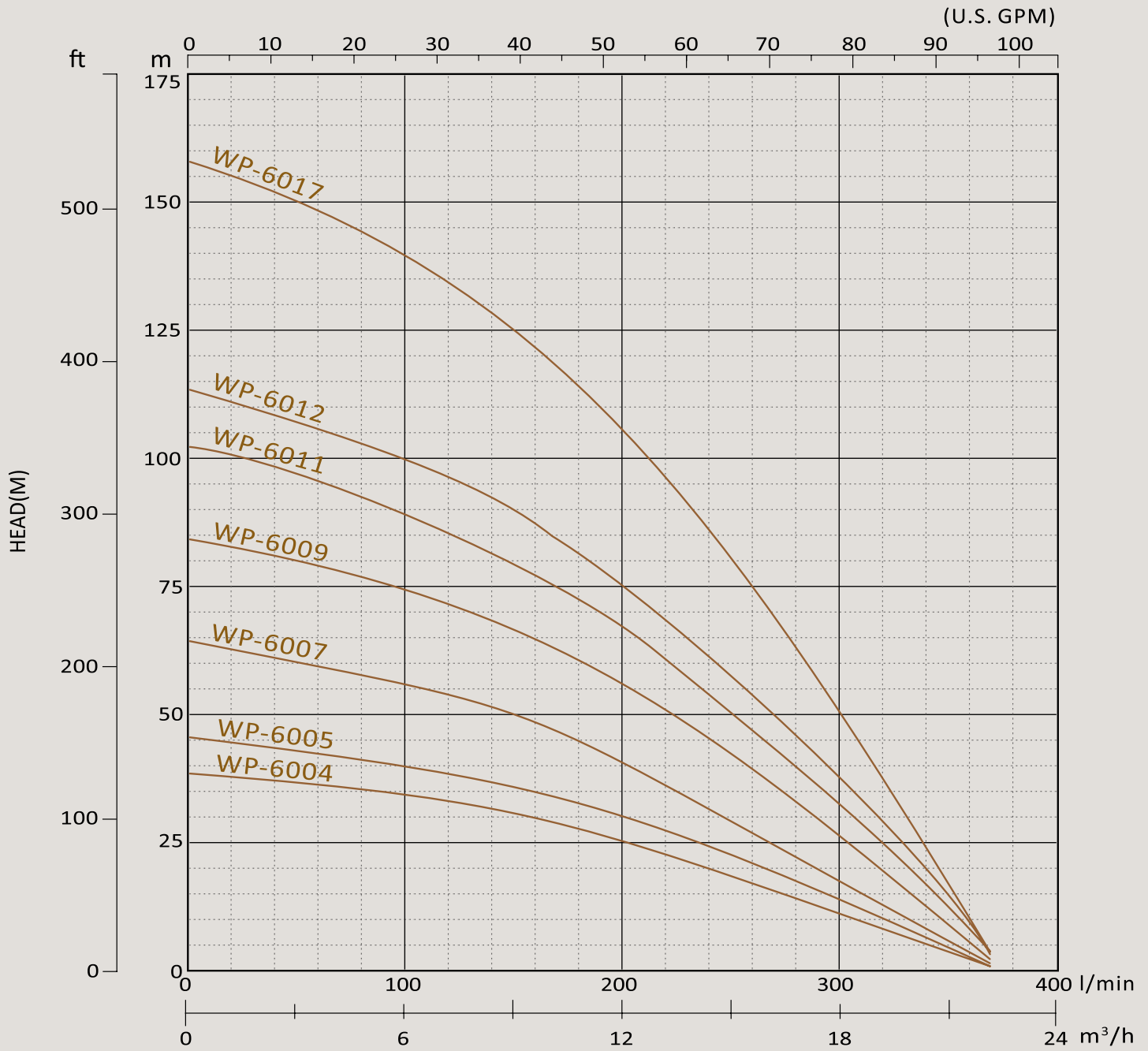

MODEL	CAPACITY		POWER		Stages	CAPACITY													Disch
	GPM	m³/hr	HP	kW		m³/hr	0	6.0	7.2	8.4	9.6	10.8	12.0	13.0	14.4	15.6	16.8	18.0	
							GPM	0	26	32	37	42	48	53	57	63	69	74	
WP-6004			1.5	1.1	4	38	36	33	31	29	27	25	22	20	18	15	12		
WP-6005			2	1.5	5	45	39	38	36	34	31	28	25	22	19	16	12		
WP-6007			3	2.2	7	64	55	53	51	48	44	39	36	32	28	23	18		
WP-6009	60	14	4	3	9	84	73	71	68	64	60	54	49	45	40	34	27		
WP-6011			5	3.7	11	101	90	87	83	78	72	65	60	54	48	42	34		
WP-6012			5.5	4	12	112	99	95	92	86	80	73	66	62	54	47	38		
WP-6017			7.5	5.5	17	158	138	134	127	120	110	101	93	84	74	65	53		

# WP-80 series / 4 Inch / 60Hz

## Specifications & Performance Curve

16

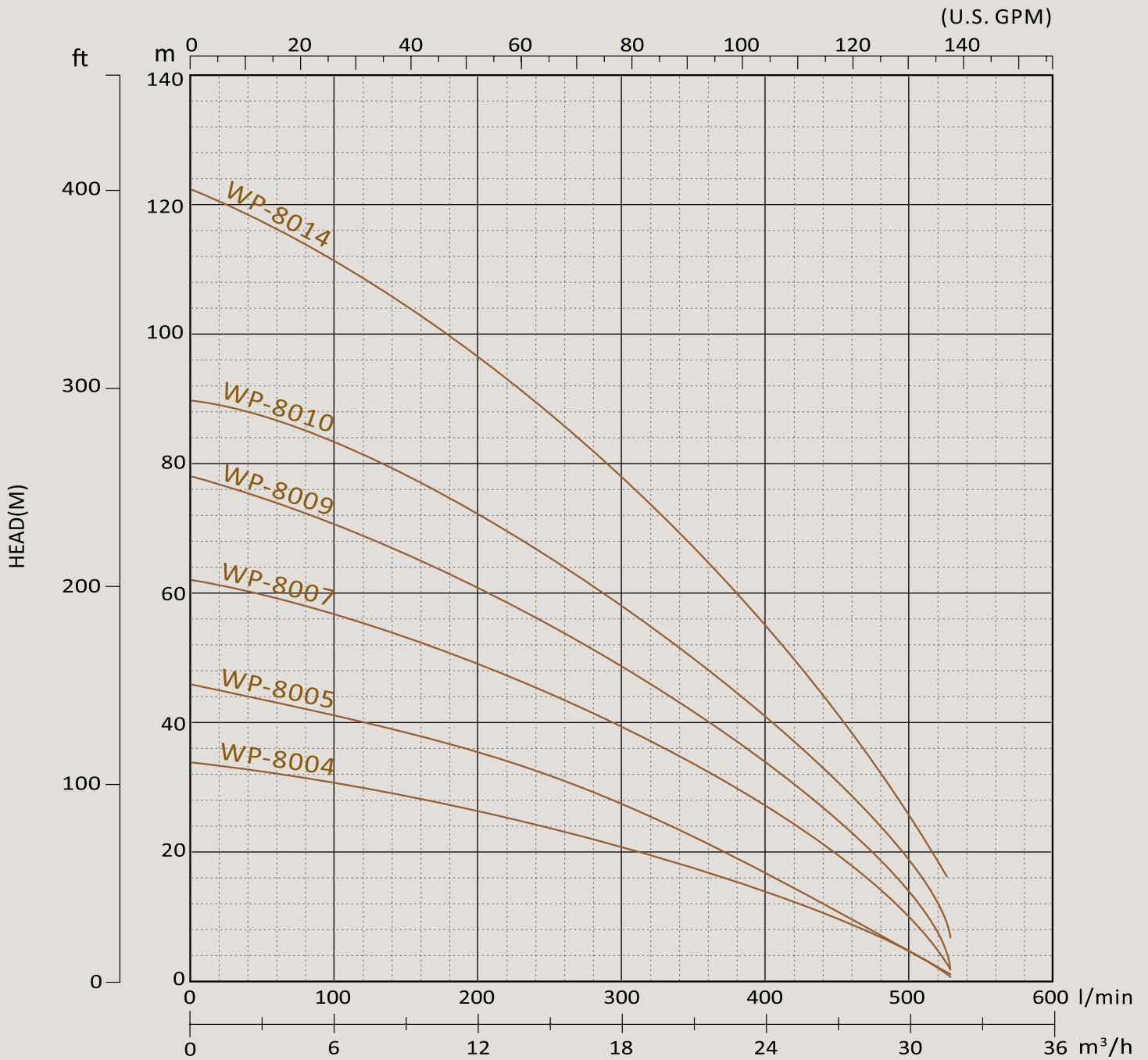

MODEL	CAPACITY		POWER		Stages	CAPACITY																	Disch
	GPM	m <sup>3</sup> /hr	HP	kW		m <sup>3</sup> /hr	0	9.6	10.8	12.0	13.0	14.4	15.6	16.8	18.0	20.4	22.8	25.2	27.6				
							GPM	0	42	48	53	57	63	69	74	79	90	100	111	122			
WP-8004	80	18	2	1.5	4	HEAD	33	28	27	26	25	24	23	21	20	17	14	12	9				
WP-8005						HEAD	43	37	35	34	33	31	30	28	27	24	20	17	13				
WP-8007						HEAD	62	53	51	49	48	45	44	42	39	35	31	25	19				
WP-8009						HEAD	77	66	63	61	58	56	54	51	49	43	37	31	24				
WP-8010						HEAD	89	76	73	71	68	65	63	60	57	52	48	37	30				
WP-8014						HEAD	122	102	99	98	92	88	86	81	78	69	60	50	40				

# WP-106 series / 6 Inch / 60Hz

17

## Specifications & Performance Curve

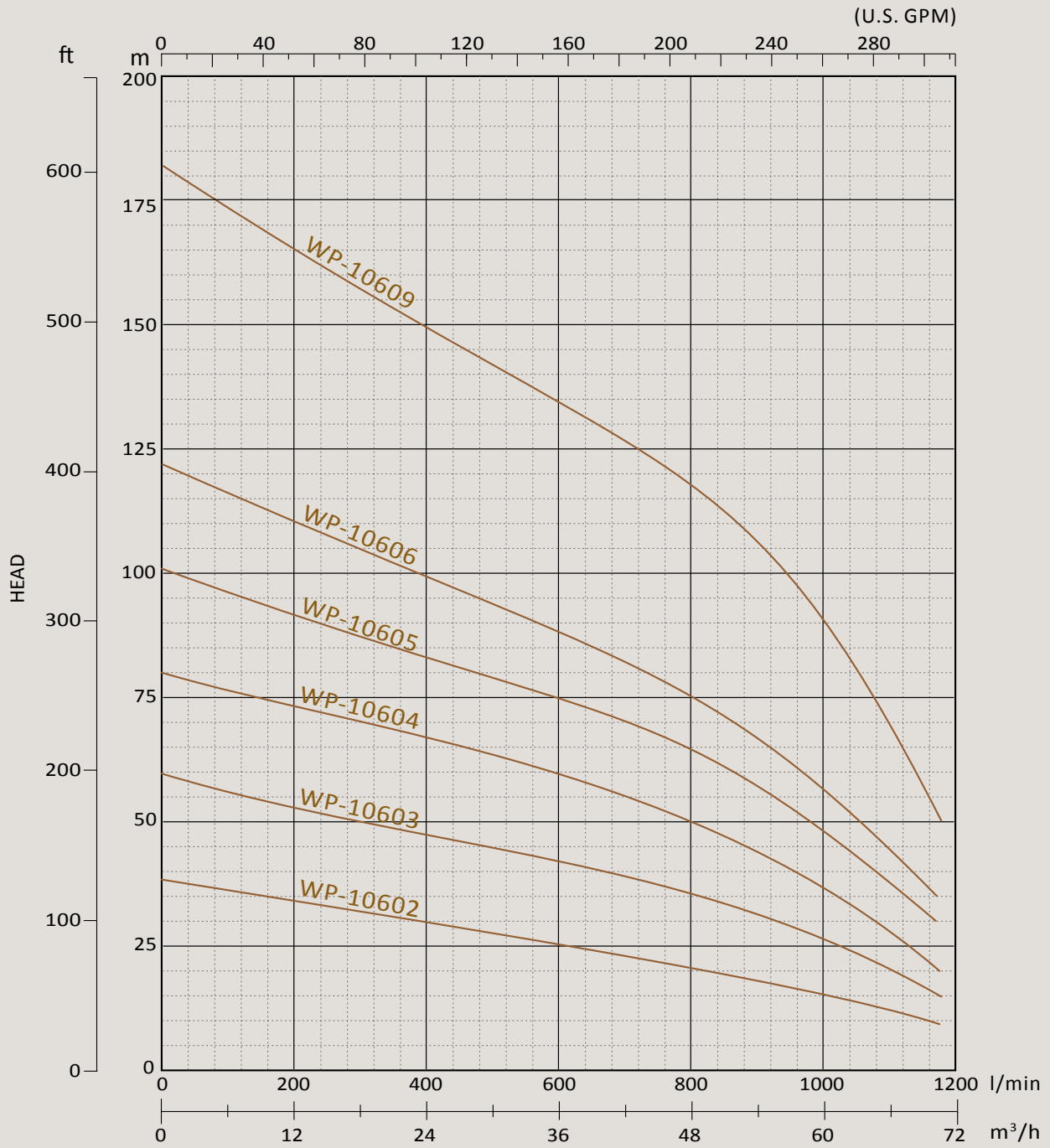

MODEL	CAPACITY		POWER		Stages	CAPACITY							Disch	
	GPM	m³/hr	HP	kW		m³/hr	0	12	24	36	48	60		66
						GPM	0	53	106	159	211	264		291
						LPM	0	200	400	600	800	1000	1100	
WP-10602			5	3.7	2		38	34	30	26	22	14	9	
WP-10603			7.5	5.5	3		59	53	48	42	36	25	17	
WP-10604			10	7.5	4		80	73	67	60	50	35	20	
WP-10605	106	24	15	11	5	HEAD (m)	101	92	82	73	65	45	31	
WP-10606			20	15	6		122	110	98	87	76	55	35	
WP-10609			25	18.5	9		182	165	149	133	117	90	50	

# WP-160 series / 6 Inch / 60Hz

## Specifications & Performance Curve

18

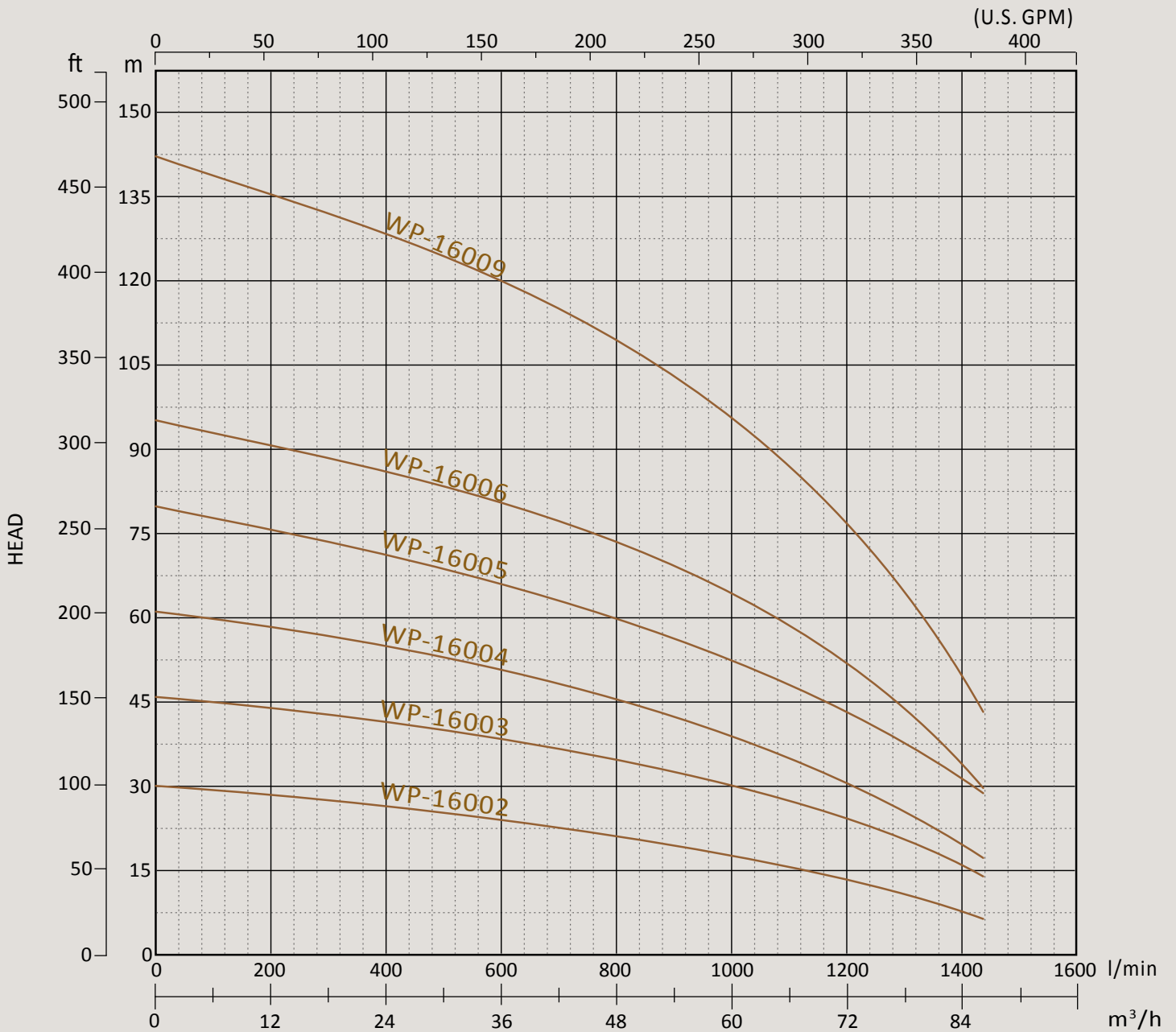

MODEL	CAPACITY		POWER		Stages	CAPACITY								Disch	
	GPM	m³/hr	HP	kW		m³/hr	0	12	24	36	48	60	72		84
						GPM	0	53	106	159	211	264	317		370
WP-16002	160	36	5	3.7	2	HEAD	30	28	26	23	20	17	13	7	
WP-16003			7.5	5.5	3	(m)	46	43	42	37	33	29	23	14	
WP-16004			10	7.5	4	62	58	56	51	45	40	31	18		
WP-16005			15	11	5	79	75	73	66	60	53	43	28		
WP-16006			20	15	6	95	90	87	78	70	62	50	30		
WP-16009			25	18.5	9	142	135	128	120	113	95	77	43		



# WP-240 series / 6 Inch / 60Hz

19

## Specifications & Performance Curve

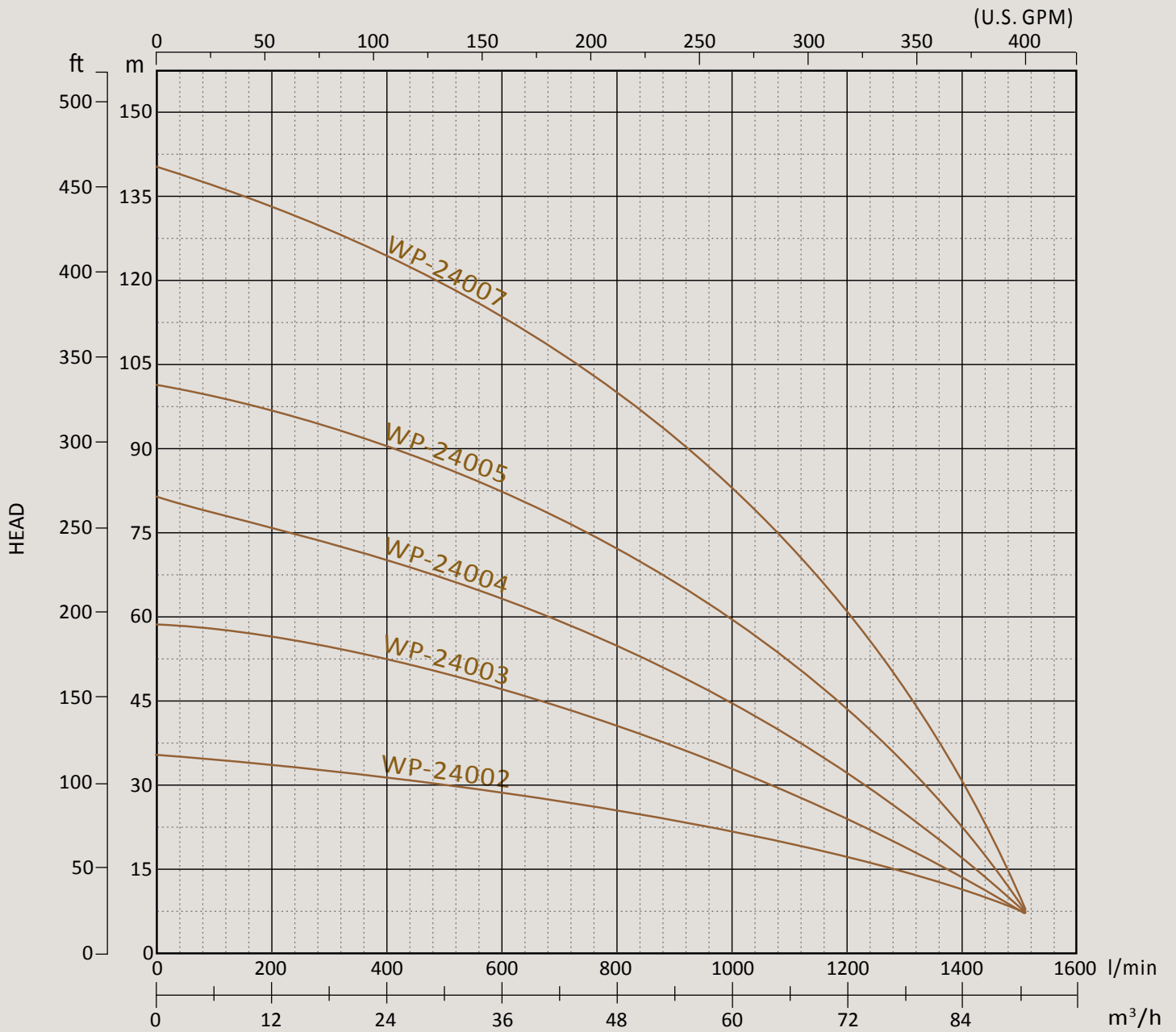

MODEL	CAPACITY		POWER		Stages	CAPACITY										Disch
	GPM	m³/hr	HP	kW		m³/hr	0	12	24	36	48	60	72	78	84	
						GPM	0	53	106	159	211	264	317	343	370	
WP-24002			7.5	5.5	2	LPM	0	200	400	600	800	1000	1200	1300	1400	
WP-24003			10	7.5	3	HEAD (m)	35	33	32	28	25	21	17	13	10	
WP-24004	240	54	15	11	4		59	55	51	47	42	34	24	18	13	
WP-24005			20	15	5		81	75	70	65	57	46	32	23	15	
WP-24007			25	18.5	7		101	95	90	83	74	60	43	33	22	
							140	134	124	113	100	84	60	46	30	

**WP-05 Series**

MODEL	LENGTH	WEIGHT
	mm	KG
WP-0507	315	2.88
WP-0510	388	3.43
WP-0513	450	4.07
WP-0518	562	5.06
WP-0524	697	6.26
WP-0532	911	8.08

**WP-15 Series**

MODEL	LENGTH	WEIGHT
	mm	KG
WP-1505	290	2.58
WP-1506	316	2.81
WP-1507	341	3.03
WP-1509	391	3.48
WP-1513	492	4.39
WP-1517	593	5.29
WP-1526	820	7.33

**WP-25 Series**

MODEL	LENGTH	WEIGHT
	mm	KG
WP-2504	270	2.40
WP-2507	350	3.10
WP-2510	435	3.80
WP-2512	490	4.30
WP-2517	665	5.90
WP-2520	710	6.40
WP-2526	921	8.20
WP-2530	1020	9.80

**WP-10 Series**

MODEL	LENGTH	WEIGHT
	mm	KG
WP-1006	293	2.69
WP-1007	315	2.89
WP-1009	360	3.28
WP-1013	450	4.08
WP-1017	540	4.87
WP-1023	674	6.06
WP-1030	866	7.69
WP-1035	978	8.91

**WP-18 Series**

MODEL	LENGTH	WEIGHT
	mm	KG
WP-1804	265	2.35
WP-1805	290	2.58
WP-1806	316	2.81
WP-1809	367	3.26
WP-1812	441	3.93
WP-1816	543	4.83
WP-1826	769	6.87
WP-1830	819	7.33

**WP-35 Series**

MODEL	LENGTH	WEIGHT
	mm	KG
WP-3506	377	3.20
WP-3507	414	3.50
WP-3509	486	4.20
WP-3513	632	5.50
WP-3516	743	6.40
WP-3520	925	8.00
WP-3522	992	8.70
WP-3532	1370	12.00

**WP-13 Series**

MODEL	LENGTH	WEIGHT
	mm	KG
WP-1304	253	2.28
WP-1305	276	2.49
WP-1307	350	2.91
WP-1310	386	3.51
WP-1312	428	3.91
WP-1318	562	5.12
WP-1329	844	7.60

**WP-40 Series**

MODEL	LENGTH	WEIGHT
	mm	KG
WP-4005	398	3.27
WP-4006	444	3.63
WP-4008	538	4.36
WP-4010	631	5.09
WP-4013	771	6.18
WP-4014	817	6.54
WP-4020	1132	8.64

**WP-55 Series**

MODEL	LENGTH	WEIGHT
	mm	KG
WP-5504	363	2.98
WP-5506	462	3.75
WP-5508	560	4.51
WP-5512	759	6.04
WP-5514	858	6.81
WP-5519	1140	9.01
WP-5523	1341	10.92

**WP-106 Series**

MODEL	LENGTH	WEIGHT
	mm	KG
WP-10602	437	7.1
WP-10603	576	9.1
WP-10604	714	11.1
WP-10605	852	13.1
WP-10606	1032	16.2
WP-10609	1447	22.1

**WP-60 Series**

MODEL	LENGTH	WEIGHT
	mm	KG
WP-6004	307	3.20
WP-6005	402	3.10
WP-6007	503	4.60
WP-6009	603	5.50
WP-6011	704	6.50
WP-6012	709	6.80
WP-6017	1009	9.50

**WP-160 Series**

MODEL	LENGTH	WEIGHT
	mm	KG
WP-16002	437	7.1
WP-16003	576	9.1
WP-16004	714	11.1
WP-16005	852	13.1
WP-16006	1032	16.2
WP-16009	1447	22.1

**WP-80 Series**

MODEL	LENGTH	WEIGHT
	mm	KG
WP-8004	435	3.90
WP-8005	500	4.40
WP-8007	639	5.20
WP-8009	778	6.30
WP-8010	846	6.80
WP-8014	1158	9.30

**WP-240 Series**

MODEL	LENGTH	WEIGHT
	mm	KG
WP-24002	437	7.1
WP-24003	576	9.1
WP-24004	714	11.1
WP-24005	852	13.1
WP-24007	1176	18.2



No. 139-18, Chung-Ho Road, Keelung, 20347, Taiwan.  
T +886-2-24378720 F +886-2-24373482  
[www.knb.com.tw](http://www.knb.com.tw) [sales@knb.com.tw](mailto:sales@knb.com.tw)